

Big Blue 302/402/502 CC Performance Data

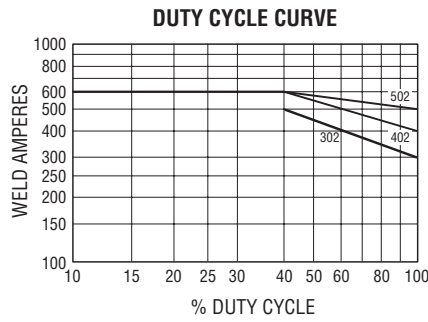

Big Blue 302/402/502 CC/CV Performance Data

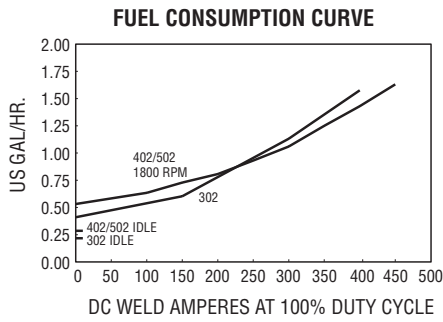
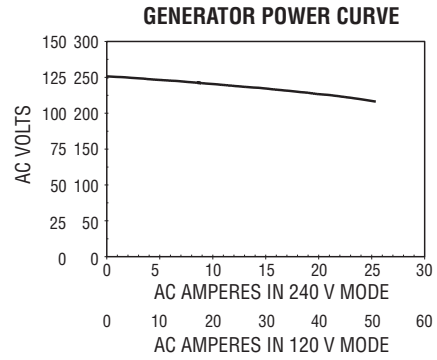
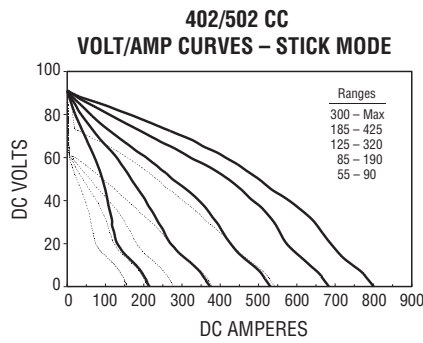
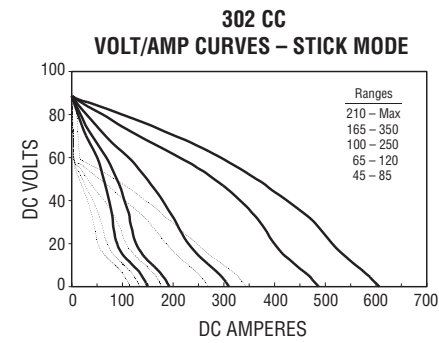
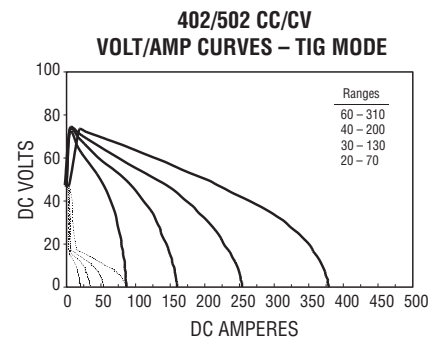
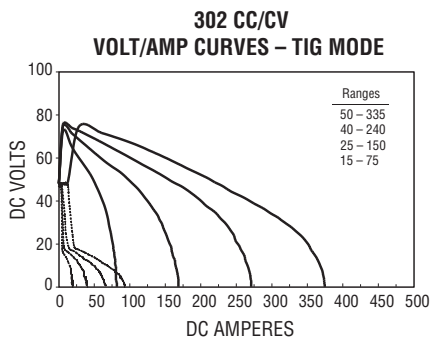
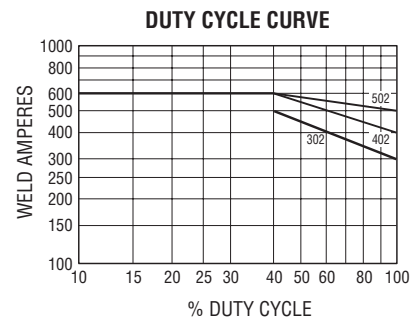
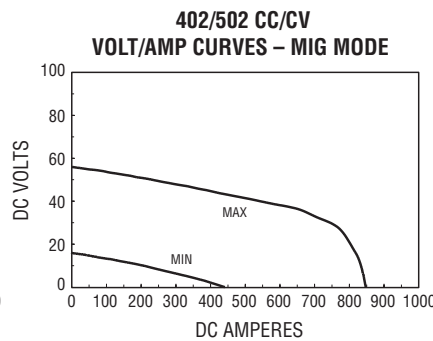
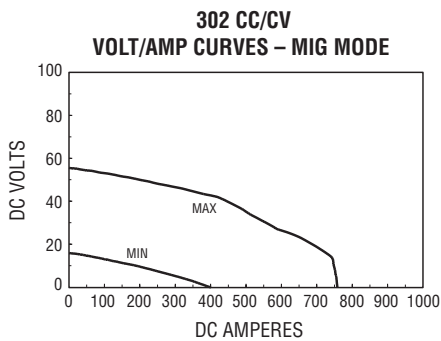
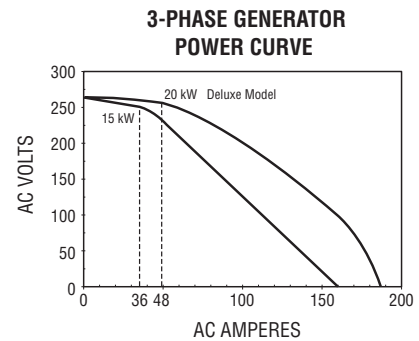
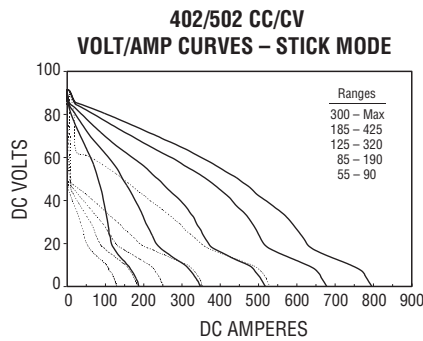
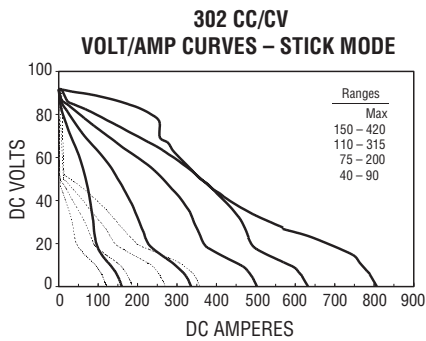

Distributed By:



www.onesourcerental.com



Engine Specifications (Subject to change without notice.)

Model	Engine Brand	Features	HP	Type	Engine Speeds (RPM)	Capacities	Automatic Engine Shutdowns
Big Blue 302	Perkins 104.22	EPA-certified, indirect-injected, liquid-cooled engine with full load sound levels of 75 dB @ 7 m (100 Lwa) . Right-side service access with service intervals of 250 hours for oil and filters .	33	4-cylinder, industrial, liquid-cooled diesel	Weld: 1800 Idle: 1235	Fuel: 25 gal (95 L) Oil: 9 qt (8.5 L) Coolant: 9 qt (8.5 L)	Oil pressure, coolant temp
	Deutz F3L1011	EPA-certified, direct-injected, air/oil-cooled engine with full load sound levels of 76.8 dB @ 7 m (101.7 Lwa) . Right-side service access with service intervals of 1000 hours for oil and filters . Approved underground operation with the purchase of a MSHA (30 CFR part 7) certificate.	30	3-cylinder, industrial, air/oil-cooled diesel	Weld: 1800 Idle: 1235	Fuel: 25 gal (95 L) Oil: 6.2 qt (5.9 L) Coolant: Integrated oil and water	Oil pressure, oil temperature
Big Blue 402	Perkins 3.1524	Direct-injected, liquid-cooled engine with full load sound levels of 80 dB @ 7 m (105 Lwa) . Left-side service access with service intervals of 400 hours for oil and filters .	45	3-cylinder, industrial, liquid-cooled diesel	Weld: 1800 Idle: 1500	Fuel: 25 gal (95 L) Oil: 6.5 qt (6.2 L) Coolant: 9 qt (8.5 L)	Oil pressure, coolant temp, low fuel
	Deutz F4L1011	EPA-certified, direct-injected, air/oil-cooled engine with full load sound levels of 76 dB @ 7 m (101 Lwa) . Right-side service access with service intervals of 1000 hours for oil and filters . Approved underground operation with the purchase of a MSHA (30 CFR part 7) certificate.	44	4-cylinder, industrial, air/oil-cooled diesel	Weld: 1800 Idle: 1235	Fuel: 25 gal (95 L) Oil: 9 qt (8.5 L) Coolant: Integrated oil and water	Oil pressure, oil temperature
Big Blue 502	Deutz F3L912	The legendary EPA-certified, direct-injected, air-cooled engine with full load sound levels of 81 dB @ 7 m (106 Lwa) . Right-side service access with service intervals of 500 hours for oil and filters .	42	3-cylinder, industrial, air-cooled diesel	Weld: 1800 Idle: N/A	Fuel: 25 gal (95 L) Oil: 9 qt (8.5 L) Coolant: Air	Oil pressure, oil temperature

Genuine Miller Options

Engine Gauge Kit

#194 700 Field
Deutz F3L912

Monitors critical engine operating parameters. Consists of individual battery voltmeter, coolant temperature and oil pressure gauges.

Installation time: 35 minutes

Weld Ammeter and Voltmeter Kit

#043 941 Field

Panel-mounted analog meters monitor welding output.

Installation time: 35 minutes

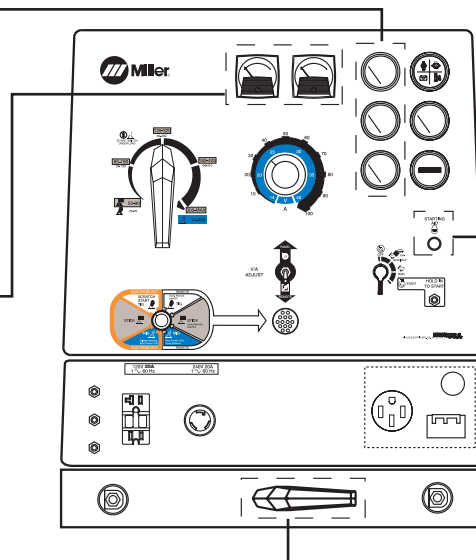

Polarity Reversing Switch Kit

#043 942 Field

Changes DC polarity without the use of tools.

Installation time: 35 minutes

Cold Weather Starting Aid Kit

Note: Perkins 3.1524 models come standard with thermostart. Installation time: 35 minutes. Perkins 104.22 models come standard with glow plugs.

#195 056 Field

Perkins 104.22. 120 volt block heater.

#043 959 Field

Deutz F3L1011 / F4L1011. 12 volt intake manifold heater.

#195 983 Field

Perkins 3.1524. 120 volt block heater.

#196 015 Field

Deutz F3L912. 12 volt ether start system. Ether tank is not provided.

3-Phase Power Generator Factory (Deluxe CC/CV model only)

For Big Blue 302 CC/CV. 15,000 watts.
For Big Blue 402/502 CC/CV. 20,000 watts.

Adds three-phase, 240 V power to CC/CV units. 12 kW, 120/240 V single-phase power from a 50 amp receptacle. Optimum kW performance achieved while not welding. This option also includes a 50 amp on/off circuit breaker for both single- and three-phase power, and a strain relief for hard wiring into the unit.

Note: Available as factory option. See Ordering Information on back page.

Distributed By:



www.onesourcerental.com

Genuine Miller Accessories

Remote Controls (CC model only)



RHC-3GD34A Remote Hand Control #041 122

Allows for precise adjustment of amperage. Includes 20 ft (6 m) cord.



RMLS-14 #129 337

Fingertip momentary- and maintained-contact rocker switch for contactor control. Push forward for maintained contact and back for momentary contact. Includes 20 ft (6 m) cord and 14-pin plug.

Extension Cords for 14-Pin Remote Controls

#122 973 25 ft (7.6 m)

#122 974 50 ft (15.2 m)

#122 975 75 ft (22.9 m)

Remote Controls (CC/CV models)



RHC-14 Hand Control #129 340

Miniature hand control for remote current and contactor control. Dimensions: 4 x 4 x 3-1/4 in (102 x 102 x 82 mm). Includes 20 ft (6 m) cord and 14-pin plug.



RCCS-14 Remote Contactor and Current Control #043 688

Up-and-down rotary-motion fingertip control fastens to TIG torch using two Velcro® straps. Includes 28 ft (8.5 m) control cord.



RFCS-14 HD Foot Control #194 744

Foot pedal provides remote current and contactor control. Includes 20 ft (6 m) cord and 14-pin plug.

TIG (GTAW) Welding



HF-251 Series

#042 388

HF-251D-1,

115 VAC

#042 387

HF-251D-2,

230 VAC

High-frequency arc

starter and stabilizer. See Accessory Lit. Index No. AY/5.0.

MIG (GMAW)/Flux Cored (FCAW) Welding



SuitCase™ 8VS #194 890

SuitCase™ 12VS #194 941

Lightweight, portable wire feeder for a variety of wires up to .062 in (8VS) or 5/64 in (12VS). Holds up to an 8 in (8VS) or 12 in (12VS) spool of wire. Includes secondary contactor and gas valve. Requires drive roll kit. See Lit. Index No. M/6.4.

Stick (SMAW) Welding



No. 2/0 Stick Welding Accessory Kits

#173 851

50 ft (15 m) No. 2/0 electrode cable with electrode holder and 50 ft (15 m) No. 2/0 work cable with work clamp. 350 A at 100% duty cycle.

#043 952

100 ft (30.5 m) No. 2/0 electrode cable with electrode holder and 50 ft (15 m) No. 2/0 work cable with work clamp. 300 A at 100% duty cycle.



Lockable Fuel Cap Flame Arrestor Kit Green

#043 947 Field

Fuel cap can be padlocked to prevent vandalism. A built-in flame arrestor prevents flames or sparks from entering the fuel tank.



Spark Arrestor Muffler Kit

#041 928 Field

Prevents particles from leaving the muffler that could potentially start a fire. Mandatory when operating on California grasslands,

brush, or forest-covered land, and in all National Forests. For other areas, check your state and local laws. Meets US Forest Service standard 5100-1B.



Vandalism Lockout Kit

#195 118 Field

Lockable hinged steel panels cover and protect name plate gauges and ignition switch (padlock

included). Also includes engine compartment door lock and key.

Distributed By:



www.onesourcerental.com



Genuine Miller Accessories (Continued)



Cable Holder #043 946
Saddle-bag-style cable holder. Convenient wrap-around storage of coiled cable for transportation. Stores 100 ft of 2/0 cable on each side.

Note: For best results do not weld when cable is coiled! Canvas cover cannot be used with cable holder.



Roll Cage/Drip Pan #194 918 Field Heavy-duty galvanized steel structure designed to protect the machine. The roll cage meets

offshore oil platform requirements with a drip pan and drain plug along with a heavy-duty lift eye.



Canvas Cover (Blue) #194 683 Field Attractive, waterproof canvas cover resists stains and mildew,

and protects the finish of your welder.

Note: Canvas cover cannot be used with cable holder.

Trailers and Hitches (For both models.)



RCT-224 Trailer #194 875
A highway trailer specifically designed for the rental/construction site. A heavy-duty

torsion axle with a low center of gravity provides a rugged yet smooth ride. The RCT-224 comes with jack stand, 2-1/2 in lunette eye, fenders, lights and safety chains.

Ball Hitch 2 in (50 mm) #189 585

For use with the RCT-224 trailer.



4 West Four-Wheel Steerable Off-Road Trailer #042 801

A heavy-duty 2570 lb (1166 kg) capacity trailer designed for use in mines, quarries, and other rough terrain. Has narrow 22 ft (6.7 m) turning radius. Includes 3 in lunette eye, universal hitch and safety chains.

Note: Trailers are shipped unassembled.



HWY-224 Trailer #043 805

A 2650 lb (1202 kg) capacity highway trailer. Welded steel tubing frame, heavy-duty axle with roller bearing hubs and leaf-spring suspension. The HWY-224 comes with jack stand, 2 in (50 mm) ball hitch, fenders and lights.

OFR-224 Trailer #043 802

A 2650 lb (1202 kg) capacity off road trailer. Welded steel tubing frame, heavy-duty axle with roller bearing hubs and leaf spring suspension. The OFR-224 comes with jack stand and 2 in (50 mm) ball hitch.

Lunette Eye 2-1/2 in (64 mm) #043 824

For use with both 224 trailers.

Cable Tree #043 826

Provides an area to conveniently wrap weld cables and extension cords. Works on all 224 and 430 trailers.



HWY-430 Tandem Axle Trailer #043 806

Smooth riding with 3750 lb (1701 kg) capacity. Includes: adjustable hitch for level operation, a hand operated parking brake, a self-actuating hydraulic brake system and a break-away device to lock brakes if the trailer comes loose. It also includes jack stand, fenders and lights. (Hitch must be ordered separately.)

Ball Hitch 2 in (50 mm) #043 864

For use with the 430 trailer.

Lunette Eye 3 in (76 mm) #043 863

For use with the 430 trailer.

Distributed By:



www.onesourcerental.com

Trailer Specifications (Subject to change without notice.)

Model	Gross Axle Weight Rating	Gross Vehicle Weight Rating	Net Payload	Height of Bed	Road Clearance	Track (Center to center of tires)	Standard Tires (Standard rating or P-size rating)	Dimensions	Net Weight
RCT-224	2700 lb (1225 kg)	2500 lb (1134 kg)	2250 lb (1021 kg)	10-1/2 in (267 mm)	6-1/2 in (165 mm)	49-1/2 in (1257 mm)	B78-13C	Length: 98 in (2489 mm) Width: 59 in (1499 mm)	285 lb (129 kg)
4 West	2000 lb/axle (907 kg/axle)	3000 lb (1361 kg)	2570 lb (1166 kg)	21-1/4 in (540 mm)	8 in (203 mm)	55-1/4 in (1403 mm)	B78-13	Length: 91 in (2311 mm)** Width: 61-1/4 in (1556 mm)	430 lb (1950 kg)
HWY-224 OFR-224	3500 lb (1588 kg)	2960 lb (1343 kg)	2650 lb (1202 kg)	18-1/2 in (470 mm)	7-1/2 in (191 mm)	52 in (1321 mm)	B78-13B	Length: 122-1/2 in (3112 mm) Width: HWY- 61 in (1549 mm)* OFR-58-1/2 in (1486 mm)	355 lb (161 kg)
HWY-430	2200 lb/axle (998 kg/axle)	4280 lb (1941 kg)	3750 lb (1701 kg)	19-1/4 in (489 mm)	8-1/2 in (216 mm)	52 in (1321 mm)	B78-13B	Length: 156-1/2 in (3975 mm) Width: 61 in (1549 mm)*	530 lb (240 kg)

* Width at outside of fenders. ** Does not include tongue.

Ordering Information

Equipment and Factory Options	Stock No.	Description	Qty.	Price
Big Blue® 302 CC	#903 799-02-1 #903 801-02-1	Deutz F3L1011, Engine Gauges, Automatic Idle Perkins 104.22, Engine Gauges, Automatic Idle		
Big Blue® 302 CC/CV	#903 800-02-1 #903 800-04-1 #903 802-02-1 #903 802-04-1	Deutz F3L1011, Engine Gauges, Automatic Idle Deutz F3L1011, Engine Gauges, Automatic Idle, Weld Meters, 15 kW Perkins 104.22, Engine Gauges, Automatic Idle Perkins 104.22, Engine Gauges, Automatic Idle, Weld Meters, 15 kW		
	Deluxe Model			
	Deluxe Model			
Big Blue® 402 CC	#903 709-02-1 #903 705-03-1	Deutz F4L1011, Engine Gauges, Automatic Idle Perkins 3.1524, Engine Gauges, Automatic Idle, Polarity Switch		
Big Blue® 402 CC/CV	#903 710-02-1 #903 710-04-1 #903 706-02-1 #903 706-04-1	Deutz F4L1011, Engine Gauges, Automatic Idle Deutz F4L1011, Engine Gauges, Automatic Idle, Weld Meters, 20 kW Perkins 3.1524, Engine Gauges, Automatic Idle Perkins 3.1524, Engine Gauges, Automatic Idle, Weld Meters, 20 kW		
	Deluxe Model			
	Deluxe Model			
Big Blue® 502 CC	#903 711	Deutz F3L912		
Big Blue® 502 CC/CV	#903 712 #903 712-03-1	Deutz F3L912 Deutz F3L912, Engine Gauges, Weld Meters, 20 kW, NO Automatic Idle		
	Deluxe Model			
Field Kit Accessories				
Engine Gauge Kit	#194 700	Deutz F3L912, oil temperature, oil pressure and battery gauges		
Weld Ammeter and Voltmeter	#043 941	For all models, analog welding meters		
Polarity Reversing Switch	#043 942	For all models, DC polarity switch		
Cold Weather Starting Aids	#195 056 #043 959 #195 983 #196 015	Perkins 104.22, 120 volt block heater Deutz F3L1011 and F4L1011, 12 volt intake manifold heater Perkins 3.1524, 120 volt block heater Deutz F3L912, ether start system		
Lockable Fuel Cap Flame Arrestor	#043 947	For all models, padlock not included		
Spark Arrestor Muffler	#041 928	For all models, vertically externally mounted		
Vandalism Lockout Kit	#195 118	For all models, lockable front control panel and engine compartment		
Cable Holder	#043 946	For all models, stores up to 200 ft of 2/O weld cable		
Roll Cage/Drip Pan	#194 918	For all models, meets offshore oil platform requirements		
Protective Cover	#194 683	For all models, will not work with cable holder accessory		
Remote Controls				
RHC-3GD34A	#041 122	CC models only, hand control		
RHC-14	#129 340	CC/CV models only, amperage or voltage control		
RCCS-14	#043 688	CC/CV models only, fingertip control		
RFCS-14 HD	#194 744	CC/CV models only, foot control		
RMLS-14	#129 337	CC/CV models only, momentary and maintained contact switch		
Remote Control Extension Cords		See page 6		
TIG Accessories				
High Frequency Arc Starters	#042 388 #042 387	HF-251D-1, 115 VAC. See Lit. Index No. AY/5.0 HF-251D-2, 230 VAC. See Lit. Index No. AY/5.0		
MIG/Flux Cored Accessories				
SuitCase™ 8VS/12VS	#194 890/#194 941	See Lit. Index No. M/6.4		
Stick Accessories				
Accessory Kits	#173 851 #043 952	2/O, 350 A, 100% duty cycle, 50 ft stinger, 50 ft work clamp 2/O, 300 A, 100% duty cycle, 100 ft stinger, 50 ft work clamp		
Trailers and Hitches				
RCT-224 Trailer	#194 875	Trailer with lights, fenders and 2-1/2 in lunette eye		
Ball Hitch, 2 in	#189 585	Replaces the 2-1/2 in lunette eye on the RCT-224		
HWY-224 Trailer	#043 805	Trailer with lights, fenders and 2 in ball hitch		
OFR-224 Trailer	#043 802	Trailer with 2 in ball hitch		
Lunette Eye, 2-1/2 in	#043 824	Replaces the 2 in ball hitch on the HWY-224 or OFR-224		
Cable Tree	#043 826	Trailer mounted cable holder for HWY-224, OFR-224 or HWY-430		
HWY-430 Trailer	#043 806	Hitch required		
Ball Hitch, 2 in	#043 864	For HWY-430 only		
Lunette Eye, 3 in	#043 863	For HWY-430 only		
4-West Trailer	#042 801	4 wheel steerable implement trailer		

Date:

Total Quoted Price:



Distributed by:



www.onesourcerental.com